

IR-Empfänger für Fernbedienungen

IR-Receiver for Remote Control Systems

Lead (Pb) Free Product - RoHS Compliant

SFH 5110



Beschreibung

SFH 5110 ist ein Infrarot-Empfänger für die Erkennung von Signalen aus Infrarot-Fernbedienungssystemen und bestehen aus Fotodiode, Vorverstärker, automatischer Verstärkungsregelung, Bandpaß-Filter und Demodulator. Das Gehäuse ist zur Unterdrückung des Tageslichteinflusses schwarz eingefärbt.

Wesentliche Merkmale

- IC mit monolithisch integrierter Fotodiode (Ein-Chip Lösung)
- Speziell geeignet für Anwendungen von 940 nm
- Hohe Empfindlichkeit
- Verschiedene Trägerfrequenzen erhältlich
- TTL und CMOS kompatibel
- Ausgang: aktiv „Low“

Anwendungen

- Empfänger in Fernbedienungen für TV, Videorecorder, HiFi, Satellitenempfänger und CD-Spieler
- Optischer Schalter

Description

SFH 5110 is a IR receiver to detect light from infrared remote control systems. The IC includes photodiode, preamplifier, automatic gain control, bandpass and demodulator. The black-colored package is designed as daylight-cutoff filter.

Features

- IC with monolithic integrated photodiode (single chip solution)
- Especially suitable for applications of 940 nm
- High sensitivity
- Various carrier frequencies available
- TTL and CMOS compatibility
- Output: active Low

Applications

- Remote control module for TV sets, VCRs, hi-fi audio receivers, SAT receivers and compact disk players
- Optical Switch

Typ Type	Trägerfrequ. Carrier Frequency kHz	Bestellnr. Ordering Code
SFH 5110-30 ¹⁾	30	Q62702P5088
SFH 5110-33 ¹⁾	33	Q62702P5089
SFH 5110-36 ¹⁾	36	Q62702P5090
SFH 5110-38	38	Q62702P5091
SFH 5110-40 ¹⁾	40	Q62702P5092

¹⁾ Mindestbestellmenge 80000 Stück / Minimum order quantity 80000 pieces

Grenzwerte ($T_A = 25\text{ °C}$)**Maximum Ratings**

Bezeichnung Parameter	Symbol Symbol	Wert Value	Einheit Unit
Betriebs- und Lagertemperatur Operation and storage temperature range	T_{op} T_{stg}	- 10 ... + 75 - 30 ... + 100	°C
Betriebsspannung Supply voltage	V_{CC}	6.3	V
Ausgangsspannung Output voltage	V_{OUT}	6.3	V
Ausgangsstrom Output current	I_{OUT}	3	mA
Verlustleistung Total power dissipation, $T_A \leq 85\text{ °C}$	P_{tot}	50	mW

Empfohlener Arbeitsbereich**Recommended Operating Conditions**

Bezeichnung Parameter	Symbol Symbol	Wert Value			Einheit Unit
		min.	typ.	max.	
Betriebstemperatur Operating temperature	T_{op}	- 10	-	75	°C
Betriebsspannung Supply Voltage	V_{CC}	4.5	5.0	5.5	V

Kennwerte ($T_A = 25\text{ °C}$)**Characteristics**

Bezeichnung Parameter	Symbol Symbol	Wert Value			Einheit Unit
		min.	typ.	max.	
Stromaufnahme, $V_{CC} = 5\text{ V}$, $E = 0$ Current consumption	I_{CC}	-	1.3	-	mA
Wellenlänge der max. Fotoempfindlichkeit Wavelength of max. sensitivity	$\lambda_{s\ max}$	-	940	-	nm
Spektraler Bereich der Fotoempfindlichkeit Spectral range of sensitivity	λ	830	-	1100	nm

Kennwerte ($T_A = 25\text{ °C}$)

Characteristics (cont'd)

Bezeichnung Parameter	Symbol Symbol	Wert Value			Einheit Unit
		min.	typ.	max.	
Ausgangsspannung Output voltage Output "High" - ($I_{out} = 10\ \mu\text{A}$) Output "Low" - ($I_{out} = 500\ \mu\text{A}$)	$V_{OUT\ high}$ $V_{OUT\ low}$	$V_{CC}-0.5$ -	- -	- 0.5	V
Trägerfrequenz Carrier frequency SFH 5110-30 SFH 5110-33 SFH 5110-36 SFH 5110-38 SFH 5110-40	f_0	-	30 33 36 38 40	-	kHz
Min. Bestrahlungsstärke (Testsignal, s. Fig. 3) Min. Threshold irradiance (test signal, see Fig. 3) $f = f_0$, $t_{p,I} = 600\ \mu\text{s}$	$E_{e\ min}$	-	0.35	0.5	mW/m^2
Min. Eingangspulsbreite „ON“ (Testsignal, s. Fig. 3) ¹⁾ Min. Input pulse width "ON" (test signal, see Fig. 3) ¹⁾	$t_{p,I}$	$6/f_0$	-	-	μs
Ausgangspulsbreite „ON“ (Testsignal, s. Fig. 3) Output pulse width "ON" (test signal, see Fig. 3 , $E_e = 1\ \text{mW}/\text{m}^2$)	$t_{p,O}$	$t_{p,I}$ $- 6/f_0$	-	$t_{p,I}$ $+ 6/f_0$	μs
50%-Filterbandbreite, $f = f_0$, $E_V = 0$, $V_{CC} = 5\ \text{V}$ 50%-Filter bandwidth	$\Delta f_{50\%}$	3	-	6	kHz

¹⁾ Die volle Empfindlichkeit wird bei einer Burstlänge von mindestens 6 Pulsen erreicht. Die Reichweite bei Verwendung eines typischen Senders (SFH 4510/SFH 4515, $I_F = 500\ \text{mA}$) beträgt etwa 30 m.

¹⁾ A minimum burst length of 6 pulses is necessary for full sensitivity. The transmission distance with a typical transmitter (SFH 4510/SFH 4515, $I_F = 500\ \text{mA}$) is about 30 m.

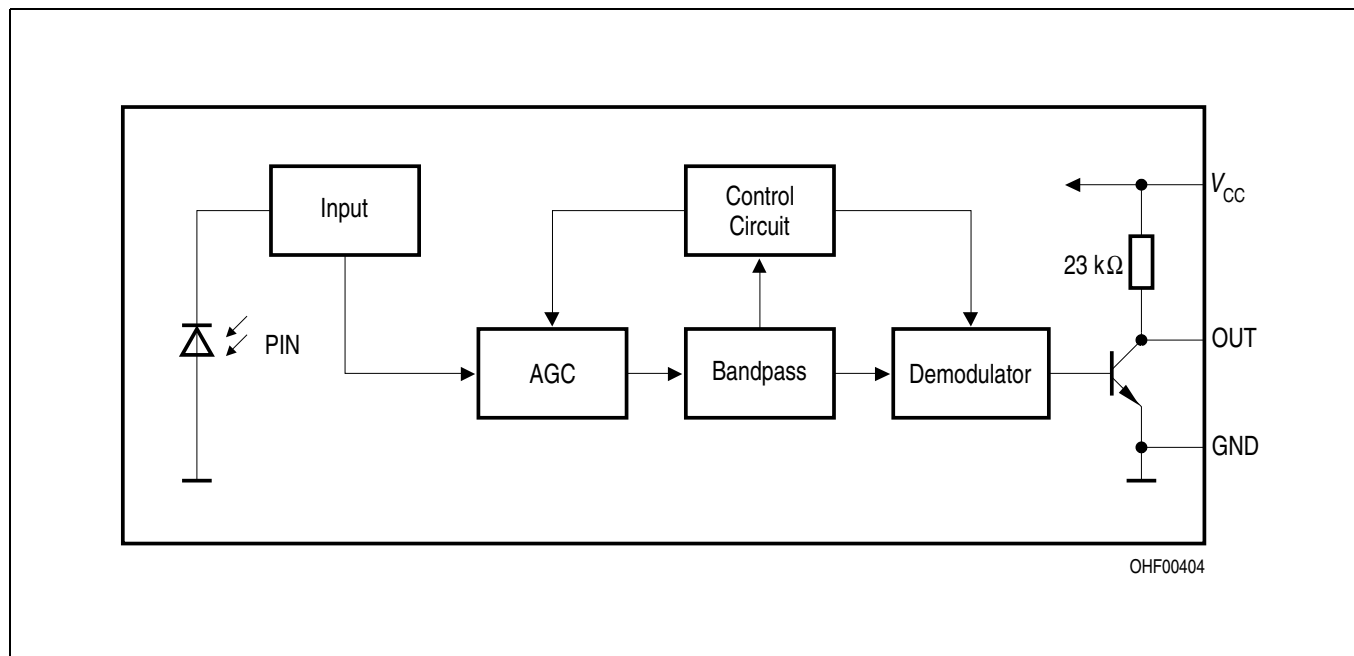

Figure 1 **Blockschaltbild**
Block Diagram

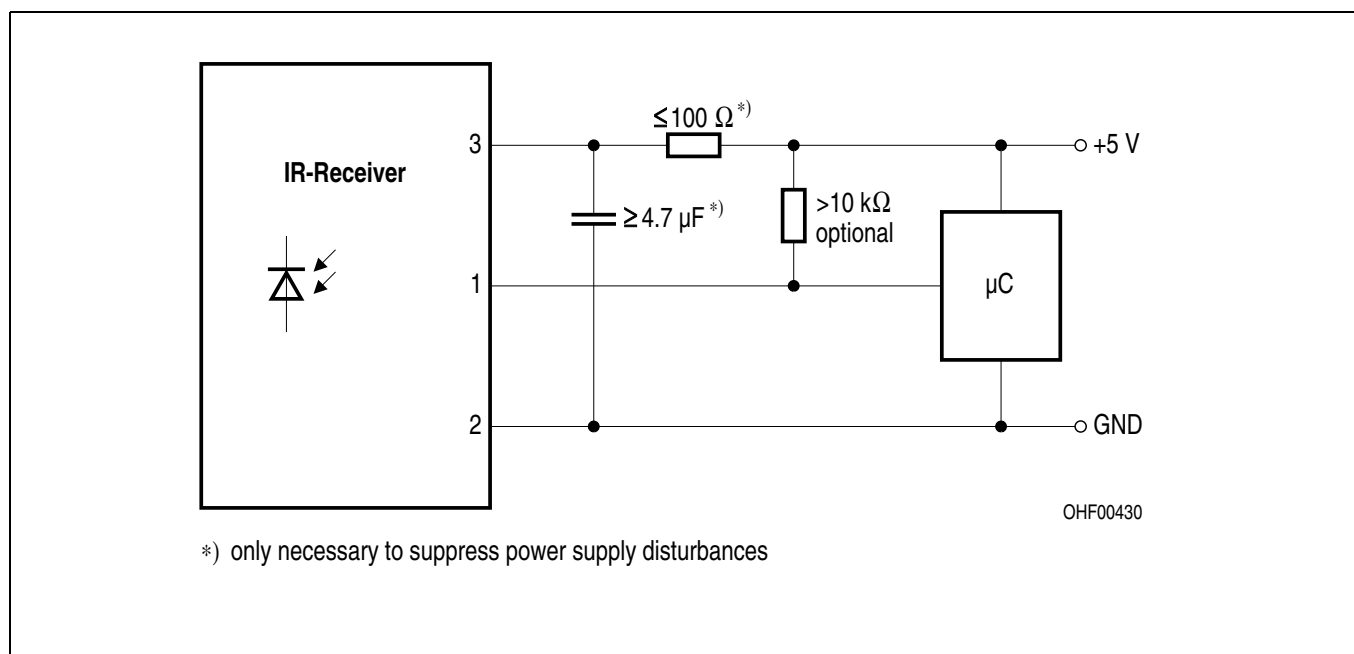

Figure 2 **Externe Beschaltung**
External Circuit

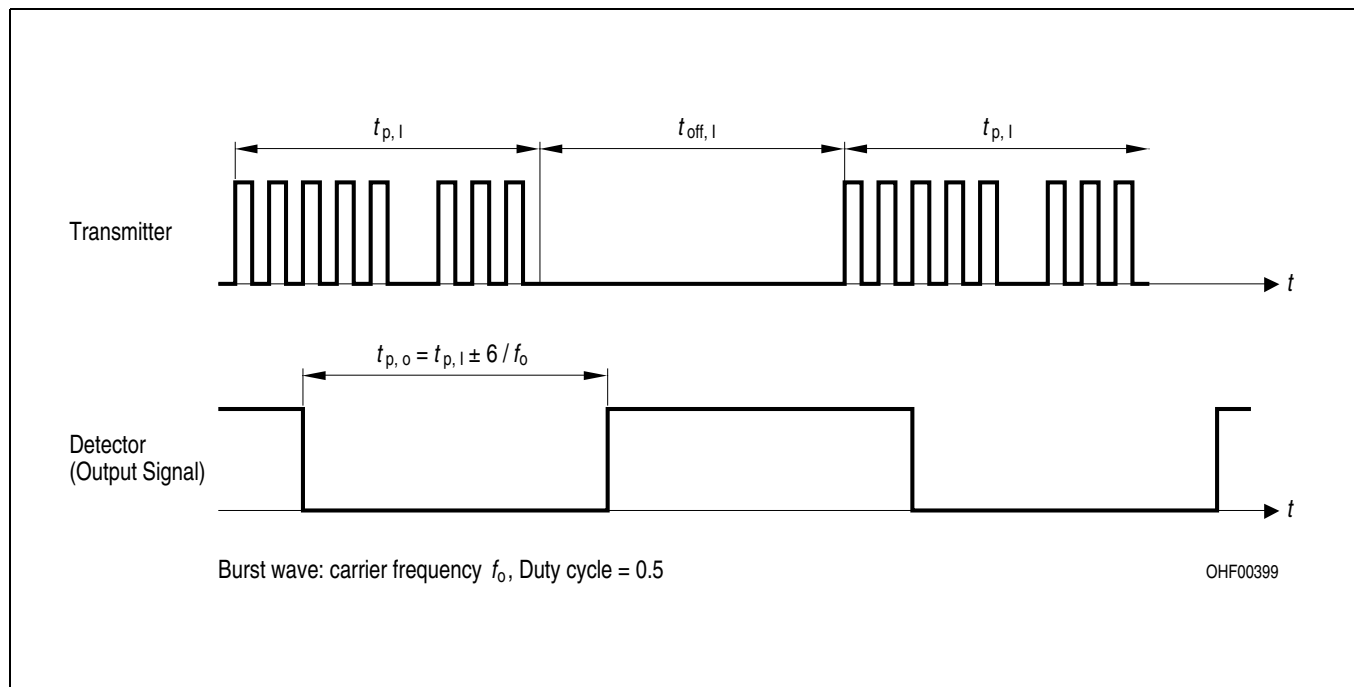
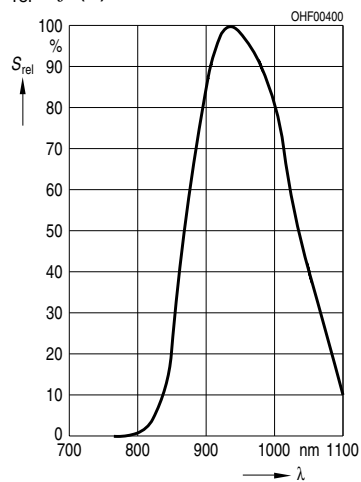

Figure 3 **Optisches Testsignal**
Optical Test Signal

Relative Spectral Sensitivity

$S_{rel} = f(\lambda)$



Vertical Directivity φ_y

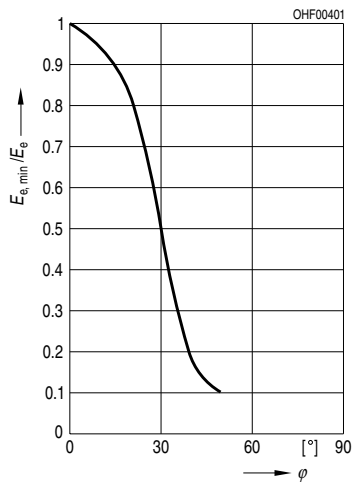

Horizontal Directivity φ_x

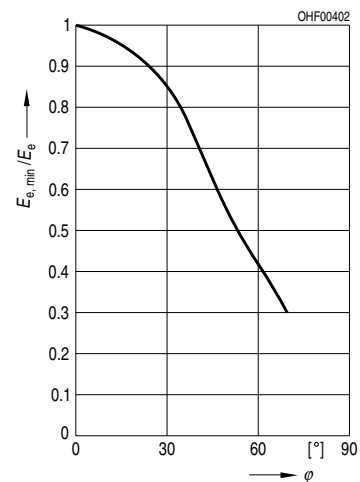

Relative Sensitivity $E_e/E_{e, min} = f(f_0)$

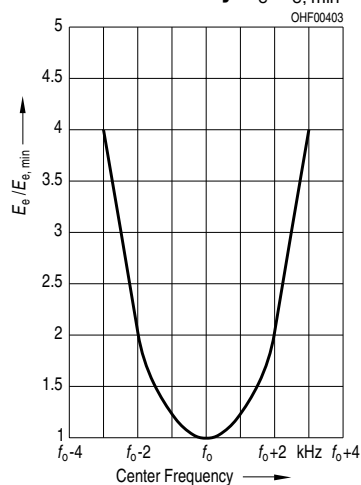

Maßzeichnung
Package Outlines

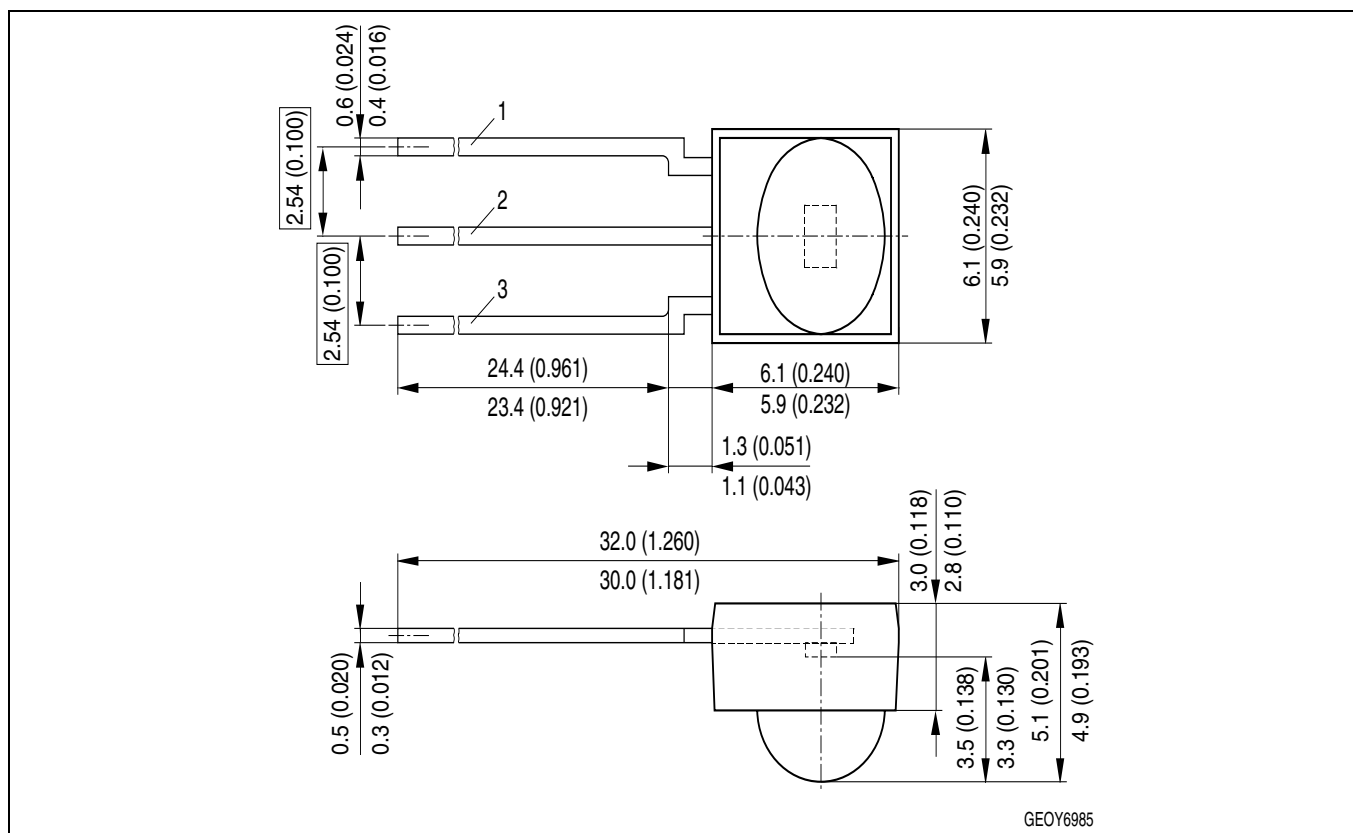

Maße werden wie folgt angegeben: mm (inch) / Dimensions are specified as follows: mm (inch).

Lötbedingungen
Soldering Conditions
Wellenlöten (TTW)
TTW Soldering

(nach CECC 00802)
(acc. to CECC 00802)

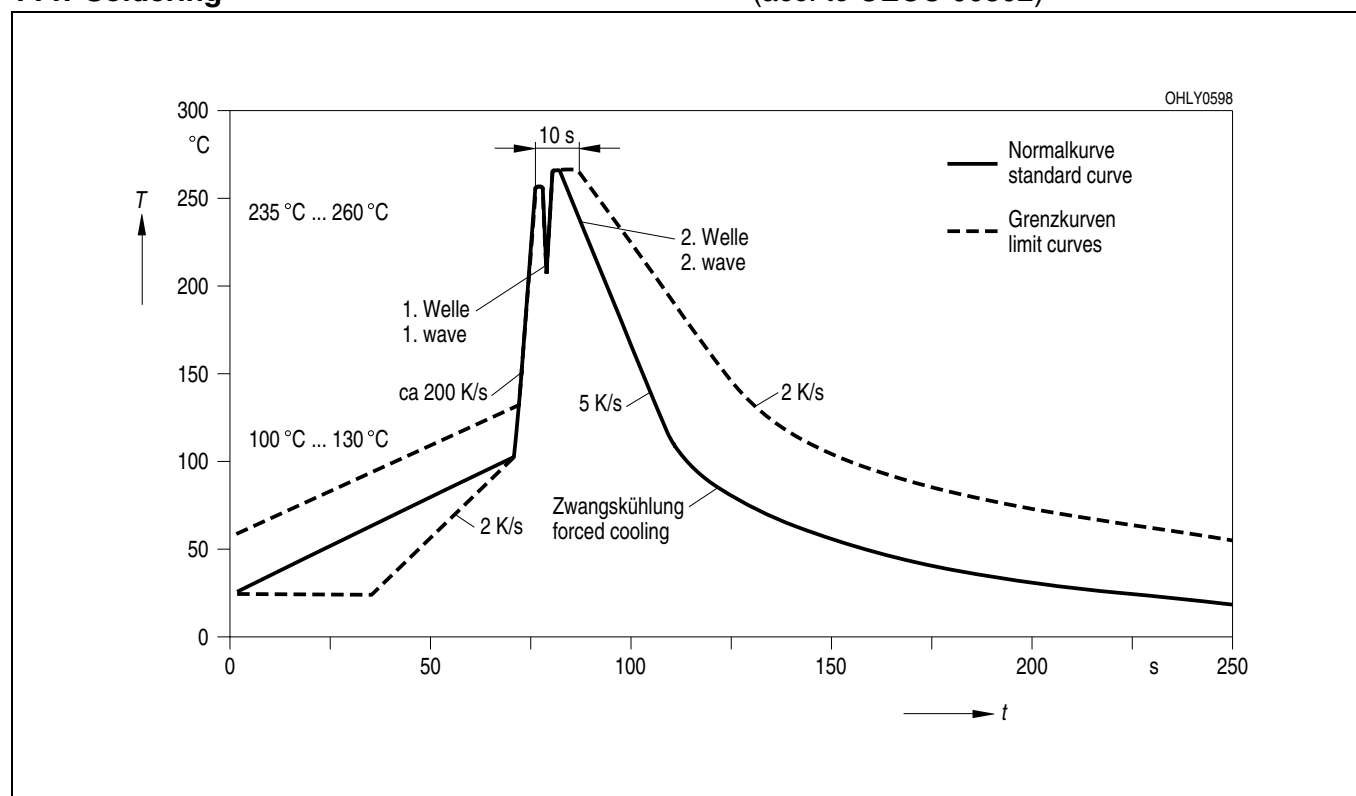

Published by
OSRAM Opto Semiconductors GmbH
Wernerwerkstrasse 2, D-93049 Regensburg

www.osram-os.com

© All Rights Reserved.

The information describes the type of component and shall not be considered as assured characteristics. Terms of delivery and rights to change design reserved. Due to technical requirements components may contain dangerous substances. For information on the types in question please contact our Sales Organization.

Packing

Please use the recycling operators known to you. We can also help you – get in touch with your nearest sales office. By agreement we will take packing material back, if it is sorted. You must bear the costs of transport. For packing material that is returned to us unsorted or which we are not obliged to accept, we shall have to invoice you for any costs incurred.

Components used in life-support devices or systems must be expressly authorized for such purpose! Critical components¹, may only be used in life-support devices or systems² with the express written approval of OSRAM OS.

¹ A critical component is a component used in a life-support device or system whose failure can reasonably be expected to cause the failure of that life-support device or system, or to affect its safety or effectiveness of that device or system.

² Life support devices or systems are intended (a) to be implanted in the human body, or (b) to support and/or maintain and sustain human life. If they fail, it is reasonable to assume that the health of the user may be endangered.